

Power System



DERMATOME & Skin Graft Mesher
BES Battery + Electro Surgical Motor Systems

www.aygun.com

AYGÜN[®]
SURGICAL INSTRUMENTS CO., INC.

Organize Sanayi Bölgesi 55330
Kutlukent - SAMSUN / TÜRKİYE
Tel : 90 (362) 266 66 80 pbx
Fax : 90 (362) 266 93 30 pbx
E-Mail : aygun@aygun.com
Web : <http://www.aygun.com>

2015

■ According to the production programme
Aygün's rights is reserved in production to improve,
modify or delete the products declared in this catalog.

KA - 4003-Y2 Copyright © Aygün Co., Inc
2015 All Right Reserved, Printed in Türkiye



AYGÜN, one of the leading establishment of Turkey in the medical industrial field, starting from neurosurgical field since 1988, at the end of its constantly R&D researches, has accomplished the production of instruments for all surgical branches. Along with meeting a large part of Turkey's requirements, it proves itself as an expert in the field with the products offered to the world market.

With present catalogues that include standard products and the special products formed on the request of the doctors including approximately 22.000 different types of instruments produced by AYGÜN. Besides being a manufacturer, it is also a designer firm.

Besides increasing its capacity, AYGÜN, in its new production plants constructed in the Organized Industrial Area of Samsun, aims to present the different models of products to the medical community.

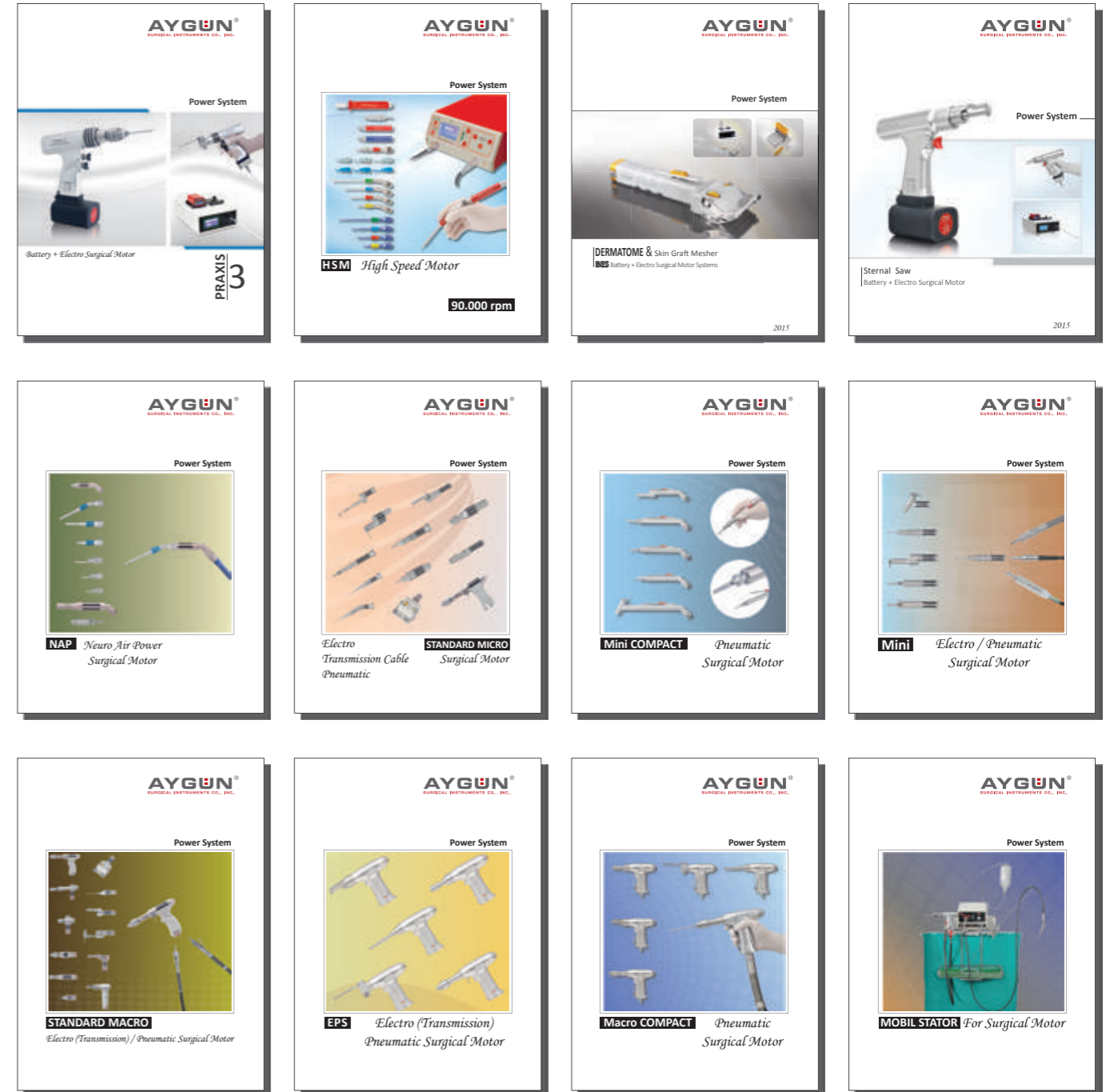



For Skin Transplantation

DERMATOME & Skin Graft Mesher
 BES Battery + Electro Surgical Motor Systems

BATTERY POWERED

1 M10-100 Dermatome handpiece

2 M14-1200 Dermatome Handpiece

3 M14-1100 Mini Dermatome Handpiece

POWER CONSOLE USE

mini



M10-100 dermatome handpiece can be operated both with battery and power cord



M14-1200 dermatome handpiece and M14-1100 mini dermatome handpiece can be operated with electric power console and pneumatic system.

CORDED USE

SKIN GRAFT MESHER

Skin graft mesher completes a full set that is sufficient for a skin transplantation operation.

PNEUMATIC USE

mini



BES DERMATOME

For Skin Transplantation

CONTENTS

SYSTEM 1



8-9

DERMATOME BATTERY USE

SYSTEM 2



10-11

DERMATOME ELECTRO USE

SYSTEM 3



12-13

DERMATOME BATTERY & ELECTRO USE

SYSTEM 4



14-15

DERMATOME POWER CONSOLE USE

16-17

MINI DERMATOME POWER CONSOLE USE

SYSTEM 5



18-19

DERMATOME PNEUMATIC USE

SYSTEM 6



20-21

MINI DERMATOME PNEUMATIC USE

SYSTEM 7



22-23

SKIN GRAFT MESHER





- M10 - 103**
Charger unit for 2 battery (without battery)
- Mains voltage 100-240 Volts, 50-60 Hz, 0.9 A
 - Charging current 1.5 A
 - Charging voltage 9.6 Volts
 - Protections: Short circuit / Overload / Over voltage
 - Dimensions: 200 x 200 x 119 mm
 - Weight: 2850 g



→ Cutting speed adjust button with safe lock.

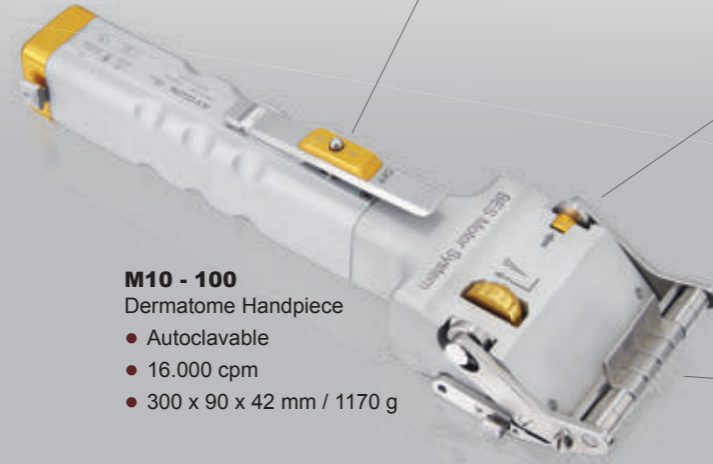

- M10 - 100**
Dermatomy Handpiece
- Autoclavable
 - 16.000 cpm
 - 300 x 90 x 42 mm / 1170 g



Dermatomy Cutting Thickness		
level	mm	inch
1	0.17	0.006
2	0.34	0.013
3	0.51	0.020
4	0.68	0.026
5	0.85	0.033
6	1.02	0.040
7	1.19	0.046



- M7 - 105**
Spare blades
One side cutting only.
stainless steel
- 10 ea.
 - 81 x 18,5 x 0,40 mm



- M10 - 102**
Rechargeable Ni-MH battery
- Not autoclavable
 - Battery capacity: 1.6 Ah
 - Voltage: 9.6 Volts
 - 136 x 32 x 32 mm / 270 g

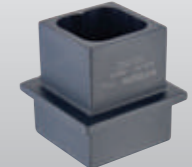

- M10 - 104**
Autoclavable sterile funnel
for aseptic battery loading
- 55 x 55 x55 mm / 60 g

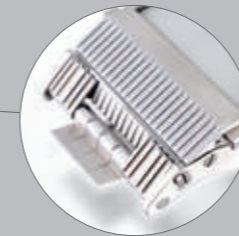

→ 8 flaps give the ability to adjust cutting width from 9.75 mm to 78 mm.



M10 - 101 Dermatomy Battery Set	
M10-100	Dermatomy Handpiece
M10-102	Rechargeable battery
M10-103	Charger Unit
M10-104	Battery loading case
M7-105	Spare blades x10 ea.
K6-247B	Sterile Container
M10-130	Basket with stand
K2-740	Paper filter x100 pcs
K2-660	Security seal x100 pcs
K2-672	Paper labels x100 pcs
K2-673	Paper labels x100 pcs



- User friendly, battery powered high torque motor design.
- No need to connect electric supply or compressed air.
- Removable special batteries make steam sterilization possible.
- Ergonomic and weight balanced design make it easy to handle.
- 8 flaps give the ability to adjust cutting width from 9.75 mm to 78 mm.
- Easy blade change mechanism designed to insert the blade only one side thus uncorrect blade insertion is avoided.
- Cutting speed can be adjusted by only one finger.
- Safe lock mechanism prevents from unwanted operation of the motor.

SET FOR STERILIZATION

- K2 - 740**
Single use paper filter 100 pcs with indicator. Aygun mark.



- M10 - 130**
Basket with stand 405 x 253 x 70 mm

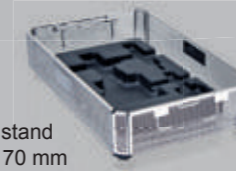

- K6 - 247B**
Sterile Container 481 x 280 x 135 mm



- K2 - 673**
Labels, paper x 100 pcs With indicator.



- K2 - 672**
Labels, paper x 100 pcs With indicator.



- K2 - 660**
Security seal made of plastic 100 pcs





M10 - 112
Power supply for direct corded use

- Mains voltage 100-240 Volts, 50-60 Hz
- Supply voltage 15 Volts, current 4A
- Protections: Short circuit / Overload / Over voltage
- Dimensions: 140 x 128 x 89 mm
- Weight: 560 g



→ Cutting speed adjust button with safe lock.

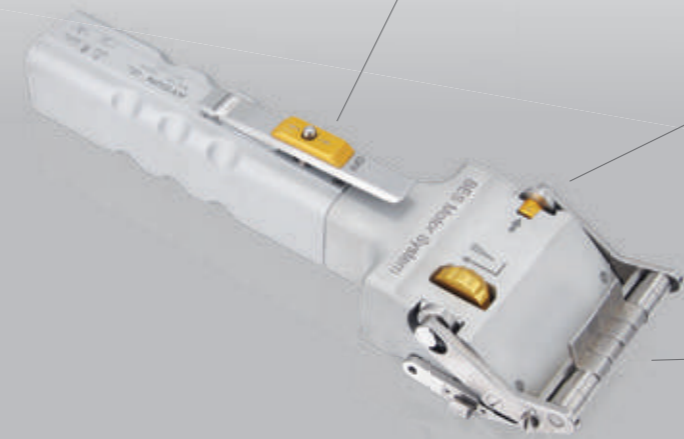

M10 - 110
Dermatome Handpiece

- Autoclavable
- 16.000 cpm
- 283 x 90 x 42 mm / 1080 g



Dermatome Cutting Thickness		
level	mm	inch
1	0.17	0.006
2	0.34	0.013
3	0.51	0.020
4	0.68	0.026
5	0.85	0.033
6	1.02	0.040
7	1.19	0.046

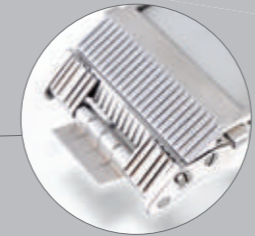

→ 8 flaps give the ability to adjust cutting width from 9.75 mm to 78 mm.



M7 - 105
Spare blades
One side cutting only.
stainless steel

- 10 ea.
- 81 x 18,5 x 0,40 mm

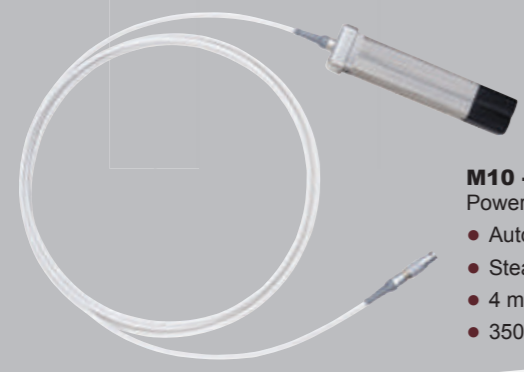

M10 - 113
Power cord for direct corded use

- Autoclavable,
- Steam sterilisable at 2 bar 134° C
- 4 m. cable length
- 350 g

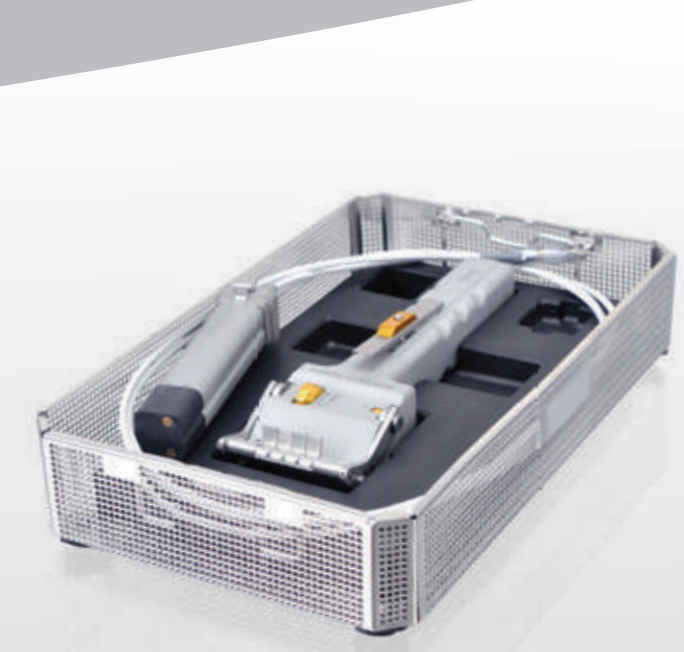

M10 - 111 Dermatome Electro Set	
M10-110	Dermatome Handpiece
M10-112	Power Supply
M10-113	Fixing socket with cable
M7-105	Spare blades x10 ea.
K6-247B	Sterile Container
M10-130	Basket with stand
K2-740	Paper filter x100 pcs
K2-660	Security seal x100 pcs
K2-672	Paper labels x100 pcs
K2-673	Paper labels x100 pcs

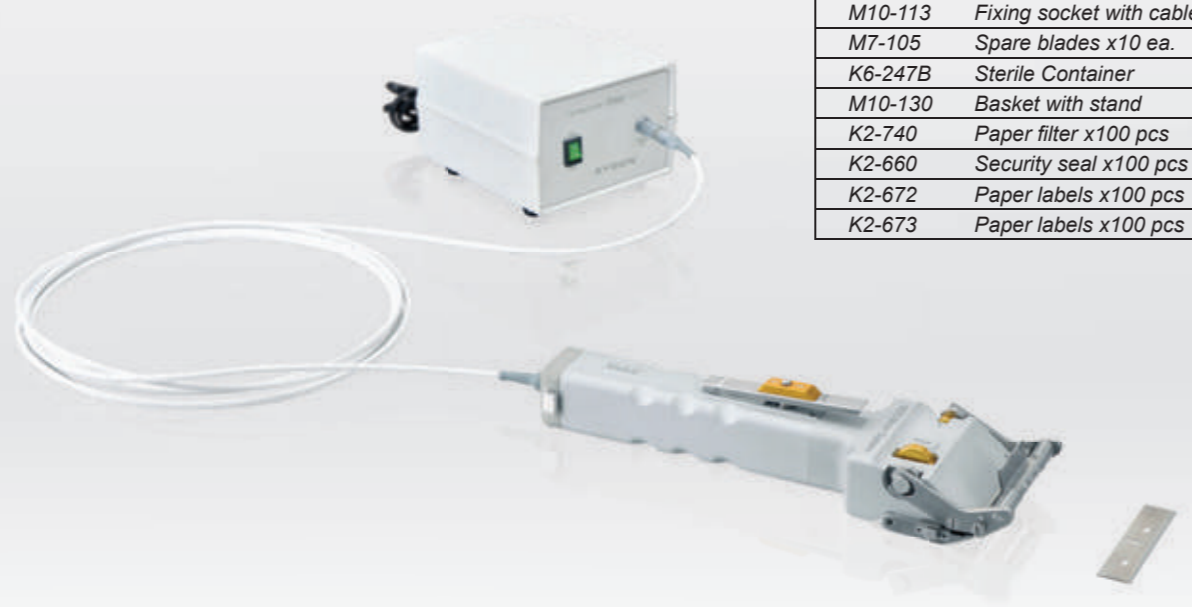

SET FOR STERILIZATION

K2 - 740
Single use paper filter 100 pcs with indicator. Aygün mark.



M10 - 130
Basket with stand 405 x 253 x 70 mm



K6 - 247B
Sterile Container 481 x 280 x 135 mm



K2 - 673
Labels, paper x 100 pcs With indicator.



K2 - 672
Labels, paper x 100 pcs With indicator.



K2 - 660
Security seal made of plastic 100 pcs





- M10 - 105**
Power supply and Charger unit for 2 battery (without battery)
- Can charge batteries and supply power for corded operation at the same time.
 - Mains voltage 100-240 Volts, 50-60 Hz, 1.5 A
 - Charging current 1.5 A
 - Charging voltage 9.6 Volts
 - Power supply 15 Volts, 4 A
 - Protections: Short circuit / Overload / Over voltage
 - Dimensions: 230 x 230 x 119 mm
 - Weight: 3210 g



→ Cutting speed adjust button with safe lock.



- M10 - 100**
Dermatome Handpiece
- Autoclavable
 - 16.000 cpm
 - 300 x 90 x 42 mm / 1170 g



Dermatome Cutting Thickness		
level	mm	inch
1	0.17	0.006
2	0.34	0.013
3	0.51	0.020
4	0.68	0.026
5	0.85	0.033
6	1.02	0.040
7	1.19	0.046



- M7 - 105**
Spare blades
One side cutting only, stainless steel
- 10 ea.
 - 81 x 18,5 x 0,40 mm



- M10 - 102**
Rechargeable Ni-MH battery
- Not autoclavable
 - Battery capacity: 1.6 Ah
 - Voltage: 9.6 Volts
 - 136 x 32 x 32 mm / 270 g

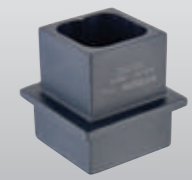

- M10 - 104**
Autoclavable sterile funnel for aseptic battery loading
- 55 x 55 x55 mm / 60 g



- M10 - 113**
Power cord for direct corded use
- Autoclavable,
 - Steam sterilisable at 2 bar 134° C
 - 4 m. cable length
 - 350 g



→ 8 flaps give the ability to adjust cutting width from 9.75 mm to 78 mm.

M10 - 121 Dermatome Battery Set	
M10-100	Dermatome Handpiece
M10-102	Rechargeable battery
M10-105	Charger Unit
M10-104	Battery loading case
M10-113	Fixing socket with cable
M7-105	Spare blades x10 ea.
K6-247B	Sterile Container
M10-130	Basket with stand
K2-740	Paper filter x100 pcs
K2-660	Security seal x100 pcs
K2-672	Paper labels x100 pcs
K2-673	Paper labels x100 pcs

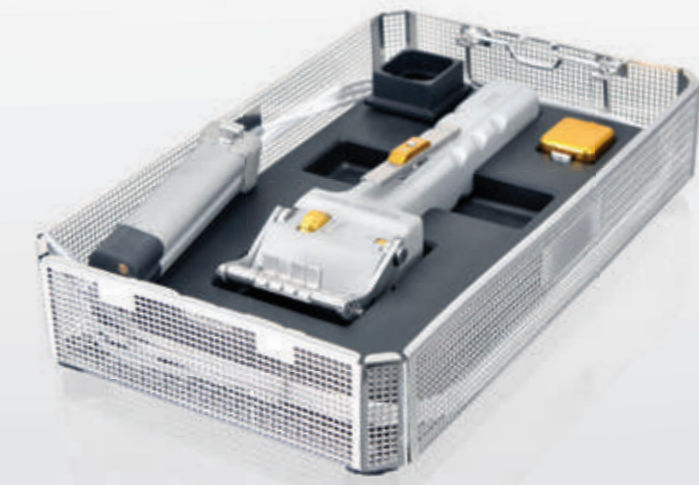

- M10 - 130**
Basket with stand
405 x 253 x 70 mm



- K6 - 247B**
Sterile Container
481 x 280 x 135 mm

SET FOR STERILIZATION

- K2 - 740**
Single use paper filter 100 pcs with indicator. Aygün mark.

- K2 - 673**
Labels, paper x 100 pcs With indicator.

- K2 - 672**
Labels, paper x 100 pcs With indicator.

- K2 - 660**
Security seal made of plastic 100 pcs



- M14 - 700**
Power console
- Operating Speed: 40.000 rpm (Adjustable Maximum Speed)
 - Operating Voltage: 200-240 V
 - Power: 260 W
 - Irrigation Flow Rate: 100 ml/min (Adjustable Maximum Flow Rate)
 - Frequency : 50-60 Hz
 - Dimensions: 350x280x110 mm
 - Weight : 5.060 kg



- M6 - 054**
Foot pedal, with irrigation and F/R buttons
- Cable Length: 4 m
 - Dimensions: 200x155x150 mm
 - Weight: 1.560 kg



- M14 - 310**
Motor Cable
- Autoclavable
 - Dimensions: 4 m
 - Weight: 490 g



- M14 - 800**
Swiss Made
Powerful Brushless
DC Motor Technology
- Autoclavable
 - Operating Speed: 40.000 rpm (Adjustable Maximum Speed)
 - Power: 150 W
 - Dimensions: 130x22 mm
 - Weight: 0.160 kg



8 flaps give the ability to adjust cutting width from 9.75 mm to 78 mm.



- M14 - 1200**
Dermatome Handpiece
(With M14-800 max: 20.000 rpm)
- Autoclavable
 - 200 x 90 x 42 mm / 960 g

Dermatome Cutting Thickness		
level	mm	inch
1	0.17	0.006
2	0.34	0.013
3	0.51	0.020
4	0.68	0.026
5	0.85	0.033
6	1.02	0.040
7	1.19	0.046



- M7 - 105**
Spare blades
One side cutting only.
stainless steel
- 10 ea.
 - 81 x 18,5 x 0,40 mm

M14 - 1201 Dermatome Electro Set	
M14-1200	Dermatome Handpiece
M6-054	Foot pedal
M14-310	Motor cable
M14-700	Power console
M14-800	Electric motor
M7-105	Spare blades x10 ea.
K6-247B	Sterile Container
M14-1230	Basket with stand
K2-740	Paper filter x100 pcs
K2-660	Security seal x100 pcs
K2-672	Paper labels x100 pcs
K2-673	Paper labels x100 pcs

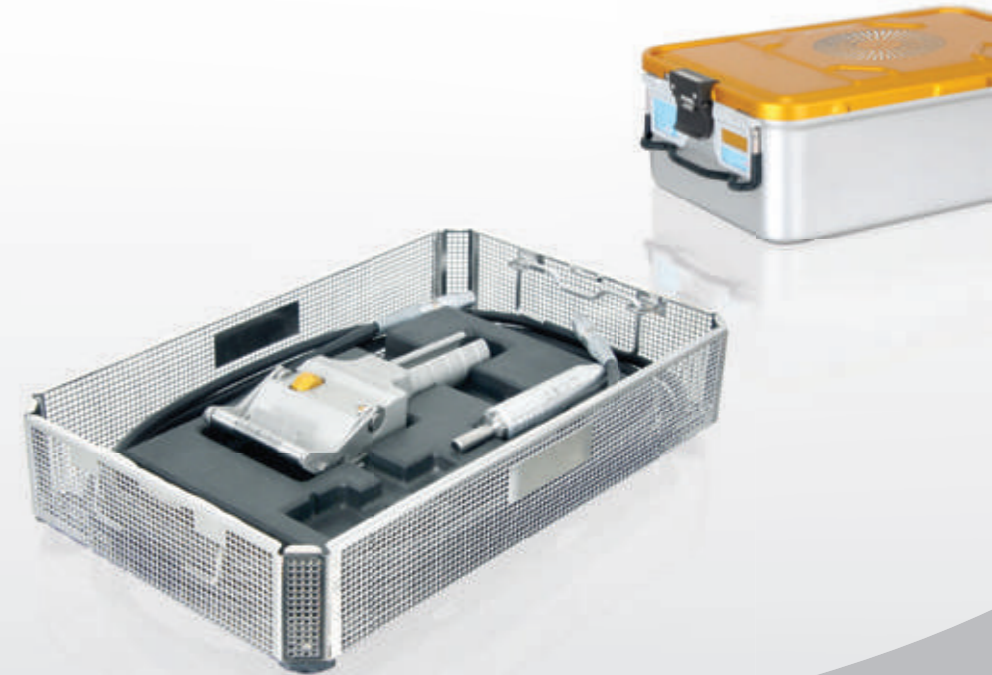

Optional attachment for SET

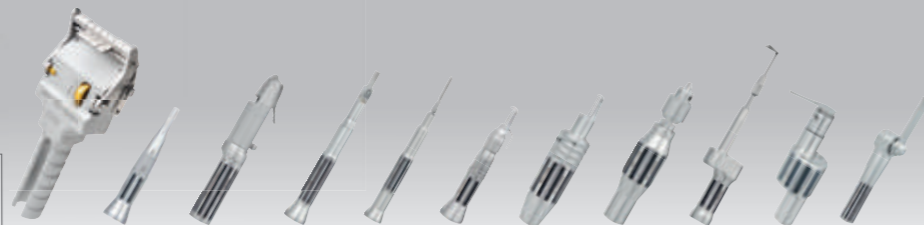

Standard MICRO ELECTRO

SET FOR STERILIZATION

- K2 - 740**
Single use paper filter 100 pcs with indicator. Aygün mark.



- K2 - 673**
Labels, paper x 100 pcs With indicator.



- M14 - 1230**
Basket with stand 405 x 253 x 70 mm



- K2 - 672**
Labels, paper x 100 pcs With indicator.



- K6 - 247B**
Sterile Container 481 x 280 x 135 mm



- K2 - 660**
Security seal made of plastic 100 pcs





- M14 - 700**
Power console
- Operating Speed: 40.000 rpm (Adjustable Maximum Speed)
 - Operating Voltage: 200-240 V
 - Power: 260 W
 - Irrigation Flow Rate: 100 ml/min (Adjustable Maximum Flow Rate)
 - Frequency : 50-60 Hz
 - Dimensions: 350x280x110 mm
 - Weight : 5.060 kg



- M6 - 054**
Foot pedal, with irrigation and F/R buttons
- Cable Length: 4 m
 - Dimensions: 200x155x150 mm
 - Weight: 1.560 kg



- M14 - 310**
Motor Cable
- Autoclavable
 - Dimensions: 4 m
 - Weight: 490 g



- M14 - 800**
Swiss Made
Powerful Brushless
DC Motor Technology
- Autoclavable
 - Operating Speed: 40.000 rpm (Adjustable Maximum Speed)
 - Power: 150 W
 - Dimensions: 130x22 mm
 - Weight: 0.160 kg

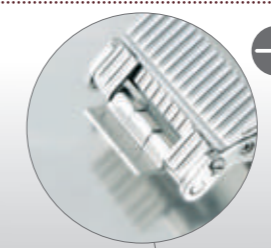

5 flaps give the ability to adjust cutting width from 8 mm to 40 mm.



- M14 - 1100**
Mini Dermatome Handpiece
(With M14-800 max: 20.000 rpm)
- Autoclavable
 - 110 x 50 x 27 mm / 180 g

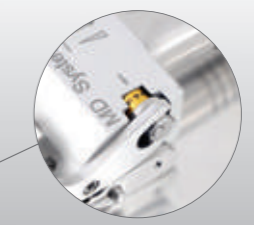

Dermatome Cutting Thickness		
level	mm	inch
1	0.17	0.006
2	0.34	0.013
3	0.51	0.020
4	0.68	0.026
5	0.85	0.033
6	1.02	0.040



- M14 - 1105**
Spare blades
One side cutting only.
stainless steel
- 10 ea.
 - 43 x 9 x 0,40 mm

M14 - 1101 Dermatome Mini Electro Set	
M14-1100	Mini Dermatome Handpiece
M6-054	Foot pedal
M14-310	Motor cable
M14-700	Power console
M14-800	Electric motor
M14-1105	Spare blades x10 ea.
K6-247B	Sterile Container
K3-750	Basket
K2-524	Silicone mat
K2-740	Paper filter x100 pcs
K2-660	Security seal x100 pcs
K2-672	Paper labels x100 pcs
K2-673	Paper labels x100 pcs



Optional attachment for SET



Standard MICRO ELECTRO

SET FOR STERILIZATION

- K2 - 524**
Silicone mat
380 x 230 mm

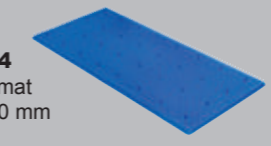

- K3 - 750**
Basket
405 x 253 x 70 mm

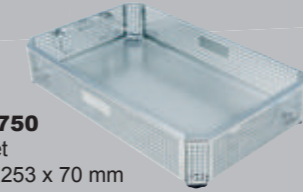

- K6 - 247B**
Sterile Container
481 x 280 x 135 mm



- K2 - 673**
Labels, paper x 100 pcs
With indicator.



- K2 - 672**
Labels, paper x 100 pcs
With indicator.



- K2 - 660**
Security seal made of
plastic 100 pcs



- K2 - 740**
Single use paper
filter 100 pcs
with indicator.
Aygun mark.





M7 - 230
Air pressure reducer
• 200 x 250 x 77 mm / 2150 g



M8 - 114
Foot control pedal, M8-116 without combining hose
• 210 x 190 x 150 mm / 3160 g



M9 - 167 > 3 m
M9 - 168 > 5 m
Combining hoses for air supply
• Autoclavable
• 630 g



M12 - 800
Pneumatic Motor
Max. Working Pressure= 6 bar (90 psi)
• Autoclavable
• 185 x 25 mm / 360 g

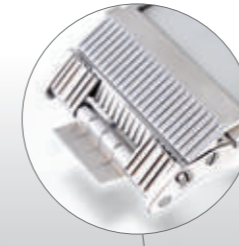

8 flaps give the ability to adjust cutting width from 9.75 mm to 78 mm.



M14 - 1200
Dermotome Handpiece
• Autoclavable
• 200 x 90 x 42 mm / 960 g



M7 - 105
Spare blades
One side cutting only.
stainless steel
• 10 ea.
• 81 x 18,5 x 0,40 mm

Dermatome Cutting Thickness		
level	mm	inch
1	0.17	0.006
2	0.34	0.013
3	0.51	0.020
4	0.68	0.026
5	0.85	0.033
6	1.02	0.040
7	1.19	0.046

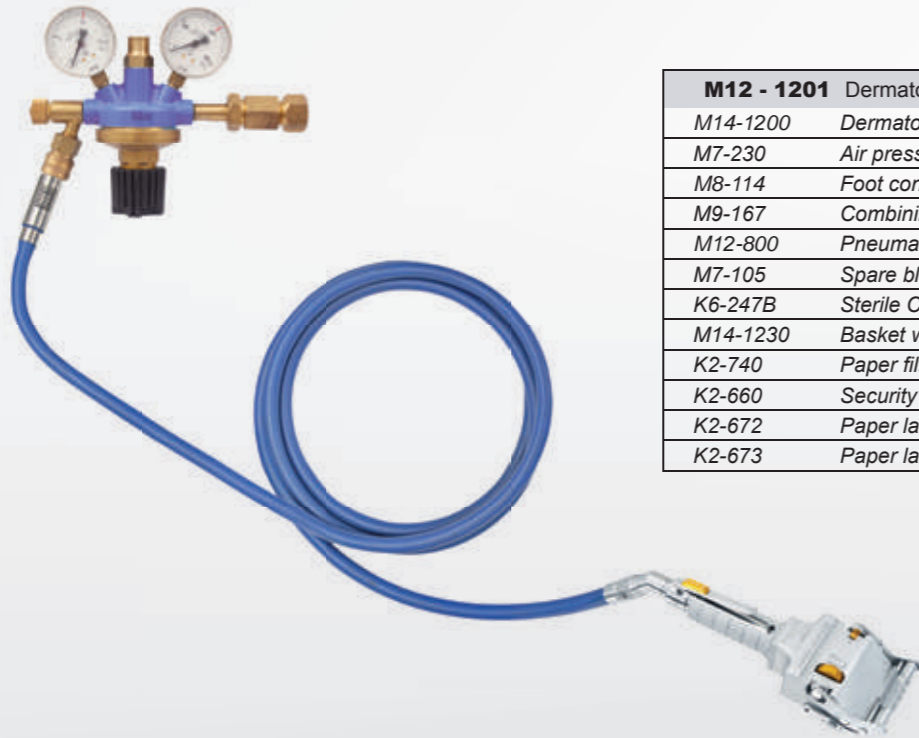

M12 - 1201 Dermotome Pneumatic Set	
M14-1200	Dermatome Handpiece
M7-230	Air pressure reducer
M8-114	Foot control pedal
M9-167	Combining hoses for air supply
M12-800	Pneumatic motor
M7-105	Spare blades x10 ea.
K6-247B	Sterile Container
M14-1230	Basket with stand
K2-740	Paper filter x100 pcs
K2-660	Security seal x100 pcs
K2-672	Paper labels x100 pcs
K2-673	Paper labels x100 pcs

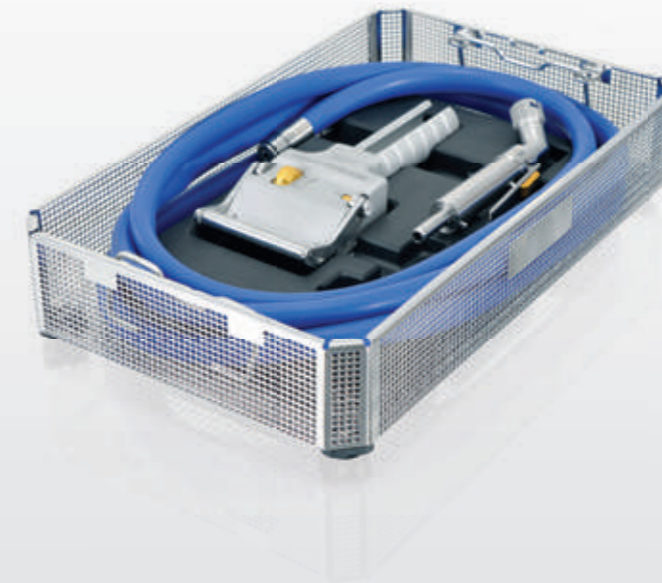

K6 - 247B
Sterile Container
481 x 280 x 135 mm



M14 - 1230
Basket with stand
405 x 253 x 70 mm



K2 - 740
Single use paper filter 100 pcs
with indicator. Aygün mark.



K2 - 660
Security seal made of
plastic 100 pcs



K2 - 672
Labels, paper x 100 pcs
With indicator.



K2 - 673
Labels, paper x 100 pcs
With indicator.



M7 - 230
Air pressure reducer
• 200 x 250 x 77 mm / 2150 g



M8 - 114
Foot control pedal, M8-116 without combining hose
• 210 x 190 x 150 mm / 3160 g



M9 - 167 > 3 m
M9 - 168 > 5 m
Combining hoses for air supply
• Autoclavable
• 630 g



M12 - 800
Pneumatic Motor
Max. Working Pressure= 6 bar (90 psi)
• Autoclavable
• 185 x 25 mm / 360 g

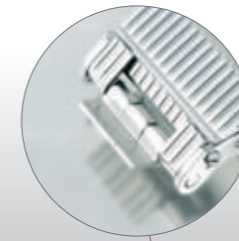

5 flaps give the ability to adjust cutting width from 8 mm to 40 mm.



M14 - 1105
Spare blades
One side cutting only.
stainless steel
• 10 ea.
• 43 x 9 x 0,40 mm



M14 - 1100
Mini Dermatome Handpiece
• Autoclavable
• 110 x 50 x 27 mm / 180 g

Dermatome Cutting Thickness		
level	mm	inch
1	0.17	0.006
2	0.34	0.013
3	0.51	0.020
4	0.68	0.026
5	0.85	0.033
6	1.02	0.040

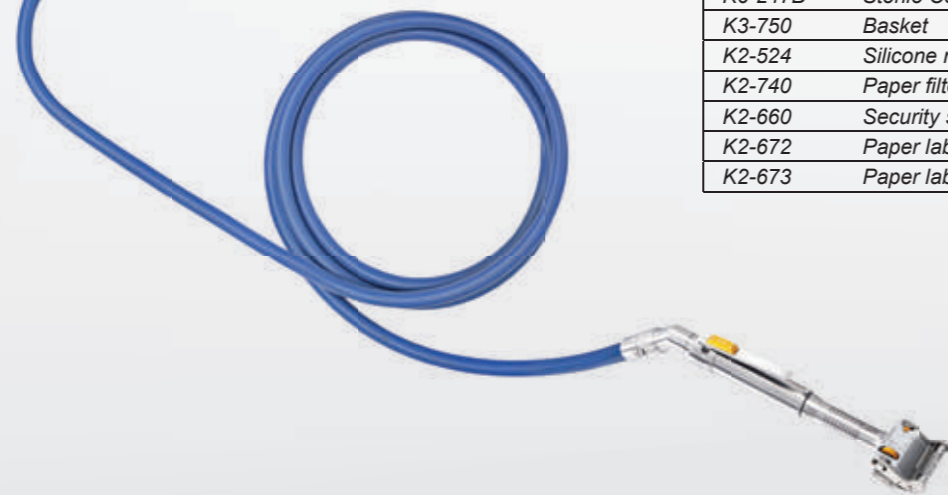

M12 - 1101 Dermatome Mini Pneumatic Set	
M14-1100	Mini Dermatome Handpiece
M8-114	Foot control pedal
M9-167	Combining hoses for air supply
M12-800	Pneumatic motor
M7-230	Air pressure reducer
M14-1105	Spare blades x10 ea.
K6-247B	Sterile Container
K3-750	Basket
K2-524	Silicone mat
K2-740	Paper filter x100 pcs
K2-660	Security seal x100 pcs
K2-672	Paper labels x100 pcs
K2-673	Paper labels x100 pcs

MINI Dermatome



K6 - 247B
Sterile Container
481 x 280 x 135 mm

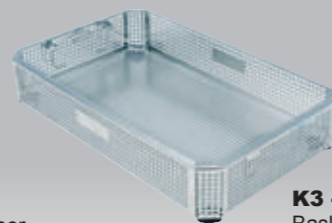

K3 - 750
Basket
405 x 253 x 70 mm

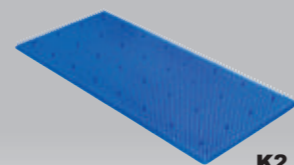

K2 - 524
Silicone mat
380 x 230 mm



K2 - 740
Single use paper filter 100 pcs
with indicator. Aygün mark.



K2 - 660
Security seal made of plastic 100 pcs



K2 - 672
Labels, paper x 100 pcs
With indicator.



K2 - 673
Labels, paper x 100 pcs
With indicator.



- Guides for Graft Carrier
- Ratchet Handle for Easy Operation
- Graft Thickness Adjustment (0-1,5 mm)

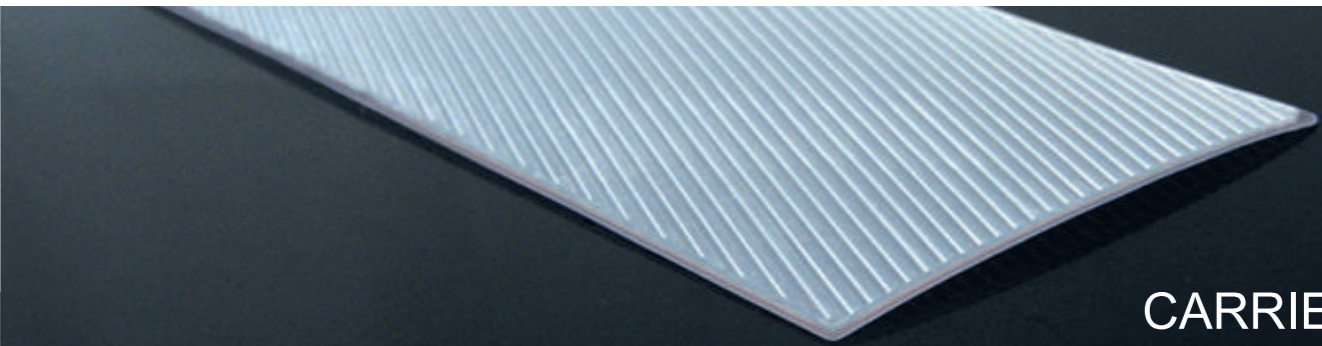

CARRIER



M11 - 500
Skin Graft Mesher
● 205 x 165 x 120 mm / 4000 g

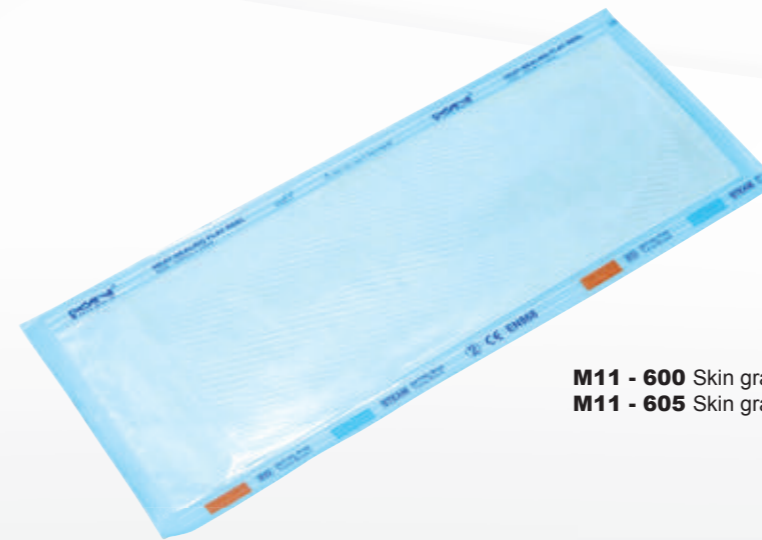

M11 - 600 Skin graft carrier > 1,5:1 (Box of 20)
M11 - 605 Skin graft carrier > 3:1 (Box of 20)

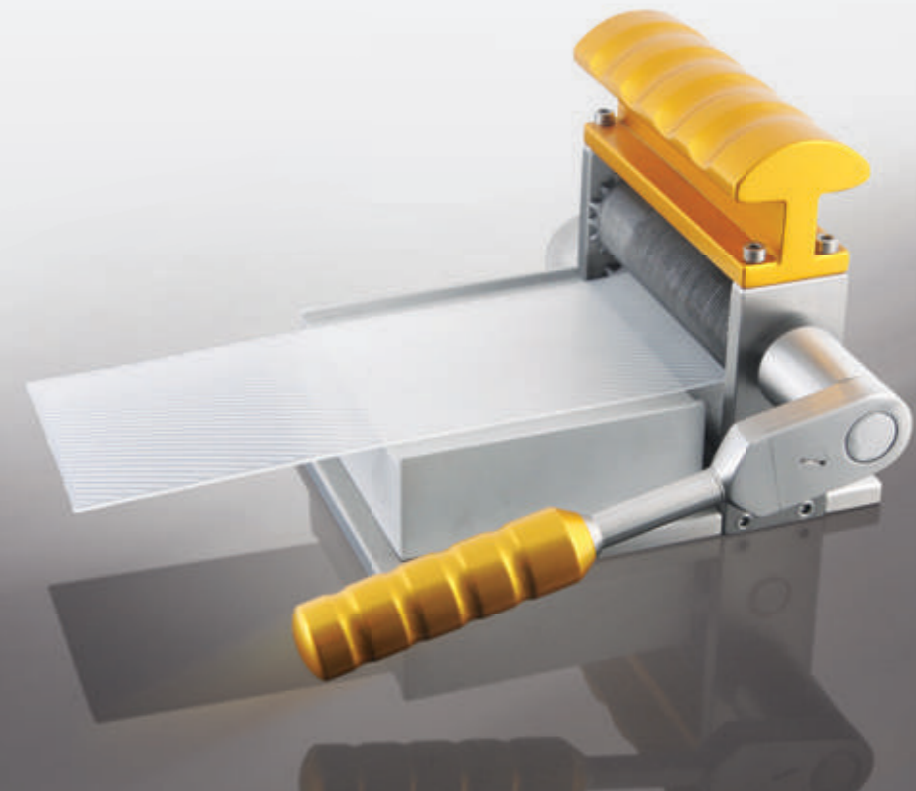

- Single cutter cuts skin graft into geometrical shaped mesh & enlarges skin surface.
- Graft expansion predetermined by graft carrying plates, eliminating need to change the cutter during operation.
- Continuous feed design prevents graft carrying plate from being loaded incorrectly and allows multiple plates to be used without interruption.
- Graft thickness adjustment feature allows expansion on thin and thick grafts.
- Easy availability of replacement parts.

DERMATOME & Skin Graft Mesher

BES Battery + Electro Surgical Motor Systems

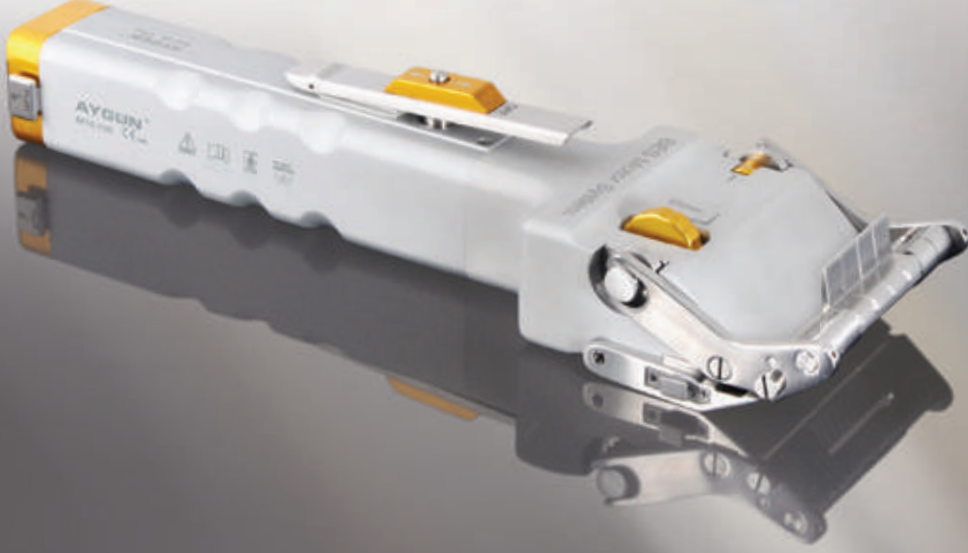

2015

Meeting Point For Surgery

AYGUN®
SURGICAL INSTRUMENTS CO., INC.

Organize Sanayi Bölgesi 55330
Kutlukent - SAMSUN / TÜRKİYE
Tel : 90 (362) 266 66 80 pbx
Fax : 90 (362) 266 93 30 pbx
E-Mail : aygun@aygun.com
Web : <http://www.aygun.com>

www.aygun.com